

Dell™ OptiPlex™ 760

Setup and Quick Reference Guide

This guide provides a features overview, specifications, and quick setup, software, and troubleshooting information for your computer. For more information about your operating system, devices, and technologies, see the *Dell Technology Guide* at support.dell.com.

Models DCSM, DCNE, DCCY, and DCTR

Notes, Notices, and Cautions

 **NOTE:** A NOTE indicates important information that helps you make better use of your computer.

 **NOTICE:** A NOTICE indicates either potential damage to hardware or loss of data and tells you how to avoid the problem.

 **CAUTION:** A CAUTION indicates a potential for property damage, personal injury, or death.

If you purchased a Dell™ n Series computer, any references in this document to Microsoft® Windows® operating systems are not applicable.

Macrovision Product Notice

This product incorporates copyright protection technology that is protected by method claims of certain U.S. patents and other intellectual property rights owned by Macrovision Corporation and other rights owners. Use of this copyright protection technology must be authorized by Macrovision Corporation, and is intended for home and other limited viewing uses only unless otherwise authorized by Macrovision Corporation. Reverse engineering or disassembly is prohibited.

Information in this document is subject to change without notice.

© 2008 Dell Inc. All rights reserved.

Reproduction of these materials in any manner whatsoever without the written permission of Dell Inc. is strictly forbidden.

Trademarks used in this text: *Dell*, the *DELL* logo, *OptiPlex*, and *DellConnect* are trademarks of Dell Inc.; *Bluetooth* is a registered trademark owned by Bluetooth SIG, Inc. and is used by Dell under license; *Intel*, *Core*, *Celeron*, and *Pentium* are registered trademarks of Intel Corporation in the U.S. and other countries; *Microsoft*, *Windows*, *Windows Vista*, and the *Windows Vista* start button logo are either trademarks or registered trademarks of Microsoft Corporation in the United States and/or other countries.

Other trademarks and trade names may be used in this document to refer to either the entities claiming the marks and names or their products. Dell Inc. disclaims any proprietary interest in trademarks and trade names other than its own.

Models DCSM, DCNE, DCCY, and DCTR

September 2008 P/N H698D Rev. A00

Contents

1	About Your Computer	7
	Desktop — Front View	7
	Desktop — Back View	8
	Desktop — Back Panel Connectors	9
	Mini Tower — Front View	10
	Mini Tower — Back View	11
	Mini Tower — Back Panel Connectors	12
	Small Form Factor — Front View	13
	Small Form Factor — Back View	14
	Small Form Factor — Back Panel Connectors	14
	Ultra Small Form Factor — Front View	15
	Ultra Small Form Factor — Back View	15
	Ultra Small Form Factor — Back Panel Connectors	16

2	Setting Up Your Computer	17
	Quick Setup	17
	Connecting the AC Power Adapter (Ultra Small Form Factor Only)	23
	Ultra Small Form Factor Cable Cover (Optional)	25
	Installing Your Computer in an Enclosure	26
	Connecting to the Internet	28
	Setting Up Your Internet Connection	28
	Transferring Information to a New Computer	30
	Microsoft® Windows Vista® Operating System.	30
	Microsoft Windows® XP	30
3	Specifications	35
4	Troubleshooting	45
	Using the Hardware Troubleshooter	45
	Tips	46
	Power Problems	46
	Memory Problems	47
	Lockups and Software Problems	48
	Dell Technical Update Service	49
	Dell Diagnostics.	50

5	Reinstalling Software	53
	Drivers	53
	Identifying Drivers	53
	Reinstalling Drivers and Utilities	54
	Restoring Your Operating System	56
	Using Microsoft® Windows® System Restore	57
	Using Dell Factory Image Restore	58
	Using the Operating System Media	60
6	Finding Information	63
7	Getting Help	65
	Obtaining Assistance	65
	Technical Support and Customer Service	66
	DellConnect™.	66
	Online Services.	66
	AutoTech Service.	67
	Automated Order-Status Service.	67
	Problems With Your Order	67
	Product Information	68
	Returning Items for Warranty Repair or Credit	68
	Before You Call	69
	Contacting Dell	71
	Index	73

About Your Computer

Desktop — Front View

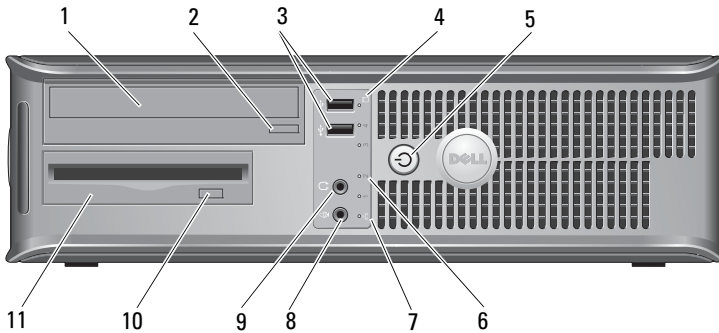

- | | | | |
|----|--|----|------------------------------------|
| 1 | optical drive | 2 | optical-drive eject button |
| 3 | USB 2.0 connectors (2) | 4 | hard-drive activity light |
| 5 | power button, power light | 6 | diagnostic lights (4) |
| 7 | network-connectivity light | 8 | microphone connector |
| 9 | headphone connector | 10 | optional floppy drive eject button |
| 11 | floppy drive or Media Card Reader (optional) | | |

Desktop — Back View

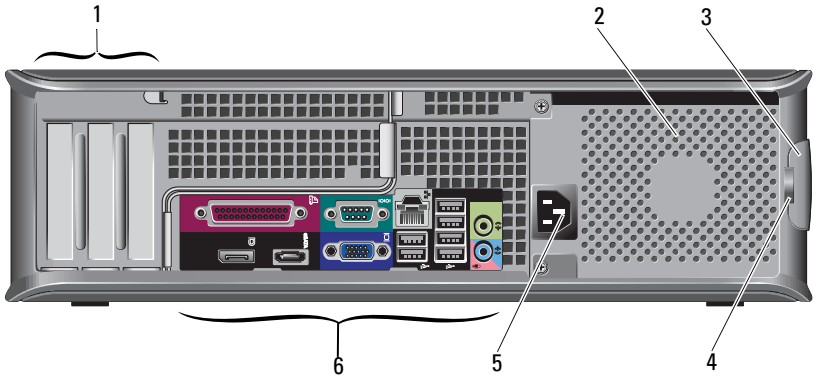

- 1 expansion-card slots (3)
- 2 air vent
- 3 cover release latch
- 4 padlock rings
- 5 power connector
- 6 back-panel connectors

Desktop — Back Panel Connectors

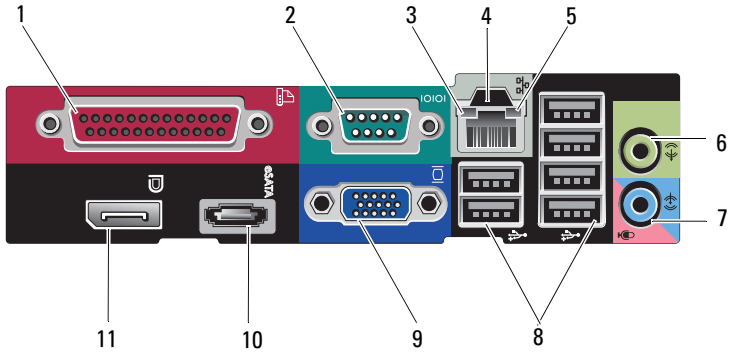

- | | | | |
|----|------------------------|----|------------------------|
| 1 | parallel connector | 2 | serial connector |
| 3 | link-integrity light | 4 | network connector |
| 5 | network-activity light | 6 | line-out connector |
| 7 | line-in connector | 8 | USB 2.0 connectors (6) |
| 9 | VGA video connector | 10 | eSATA connector |
| 11 | DisplayPort connector | | |

Mini Tower — Front View

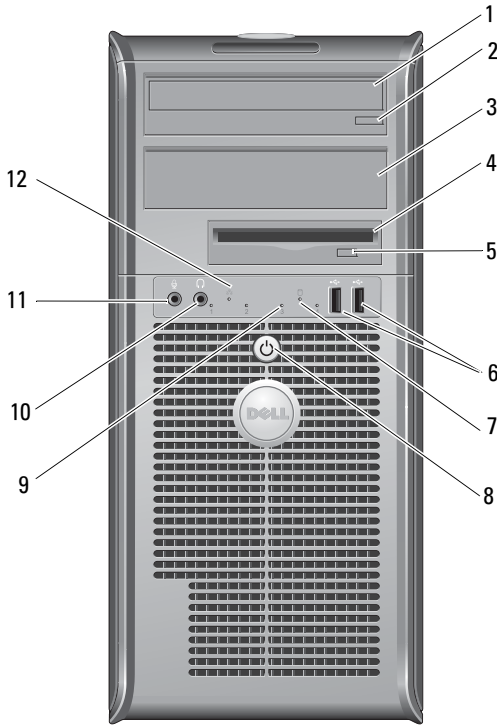

- | | | | |
|----|------------------------------------|----|--|
| 1 | optical drive | 2 | optical-drive eject button |
| 3 | optional optical drive bay | 4 | floppy drive or Media Card Reader (optional) |
| 5 | optional floppy drive eject button | 6 | USB 2.0 connectors (2) |
| 7 | hard-drive activity light | 8 | power button, power light |
| 9 | diagnostic lights (4) | 10 | headphone connector |
| 11 | microphone connector | 12 | network-connectivity light |

Mini Tower — Back View

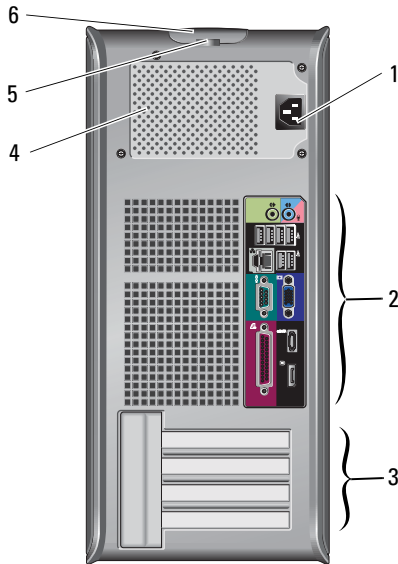

- | | | | |
|---|--------------------------|---|-----------------------|
| 1 | power connector | 2 | back-panel connectors |
| 3 | expansion-card slots (4) | 4 | air vent |
| 5 | padlock rings | 6 | cover release latch |

Mini Tower — Back Panel Connectors

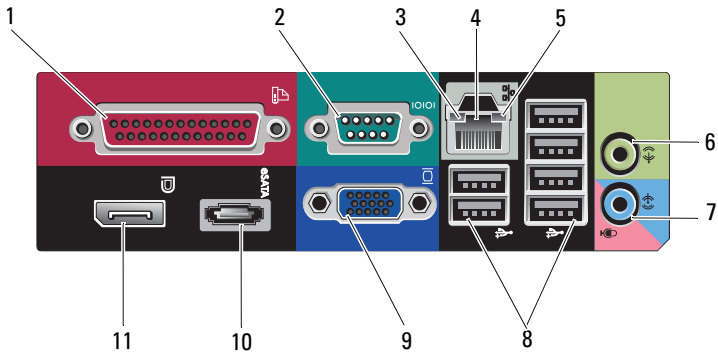

- | | | | |
|----|------------------------|----|------------------------|
| 1 | parallel connector | 2 | serial connector |
| 3 | link-integrity light | 4 | network connector |
| 5 | network-activity light | 6 | line-out connector |
| 7 | line-in connector | 8 | USB 2.0 connectors (6) |
| 9 | VGA video connector | 10 | eSATA connector |
| 11 | DisplayPort connector | | |

Small Form Factor — Front View

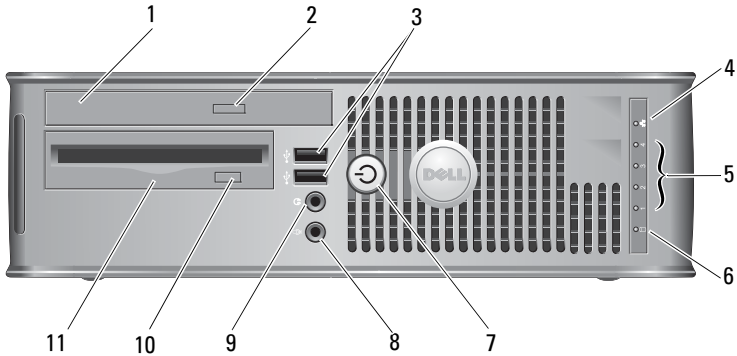

- | | | | |
|----|--|----|------------------------------------|
| 1 | optical drive | 2 | optical-drive eject button |
| 3 | USB 2.0 connectors (2) | 4 | network-connectivity light |
| 5 | diagnostic lights (4) | 6 | hard-drive activity light |
| 7 | power button, power light | 8 | microphone connector |
| 9 | headphone connector | 10 | optional floppy drive eject button |
| 11 | floppy drive or Media Card Reader (optional) | | |

Small Form Factor — Back View

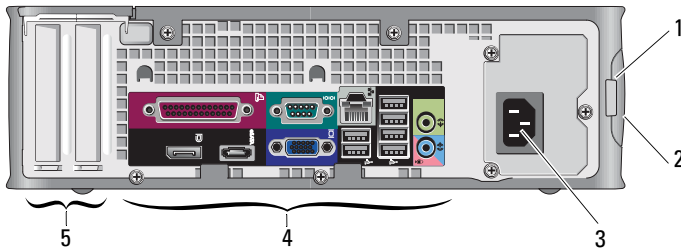

- | | | | |
|---|--------------------------|---|-----------------------|
| 1 | padlock rings | 2 | cover release latch |
| 3 | power connector | 4 | back-panel connectors |
| 5 | expansion-card slots (2) | | |

Small Form Factor — Back Panel Connectors

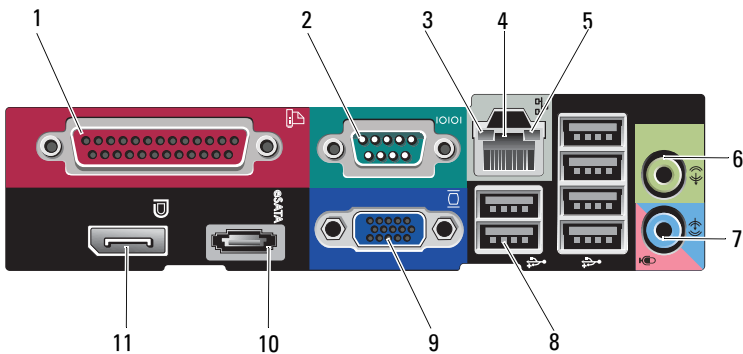

- | | | | |
|----|------------------------|----|------------------------|
| 1 | parallel connector | 2 | serial connector |
| 3 | link-integrity light | 4 | network connector |
| 5 | network-activity light | 6 | line-out connector |
| 7 | line-in connector | 8 | USB 2.0 connectors (6) |
| 9 | VGA video connector | 10 | eSATA connector |
| 11 | DisplayPort connector | | |

Ultra Small Form Factor — Front View

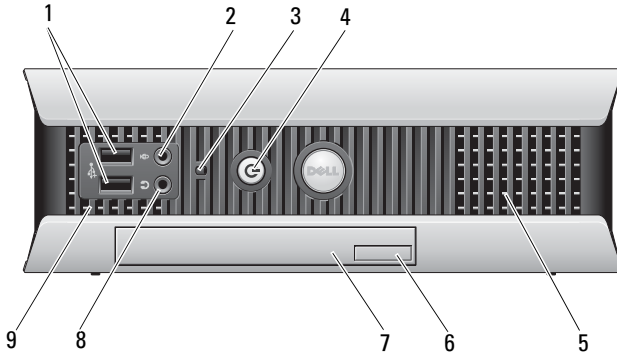

- | | | | |
|---|---------------------------|---|----------------------------|
| 1 | USB 2.0 connectors (2) | 2 | microphone connector |
| 3 | hard drive activity light | 4 | power button, power light |
| 5 | air vents | 6 | optical-drive eject button |
| 7 | optical drive | 8 | headphone connector |
| 9 | air vents | | |

Ultra Small Form Factor — Back View

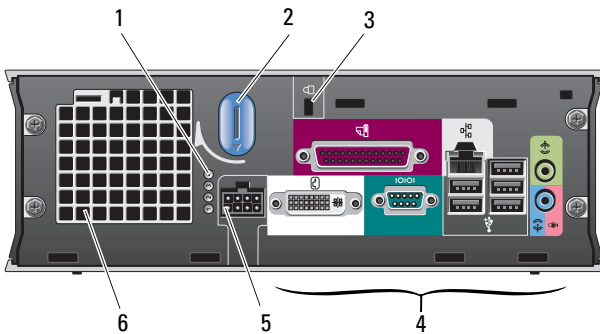

- | | | | |
|---|-----------------------|---|-----------------------|
| 1 | diagnostic lights (4) | 2 | cover release knob |
| 3 | security cable slot | 4 | back-panel connectors |
| 5 | power connector | 6 | air vent |

Ultra Small Form Factor — Back Panel Connectors

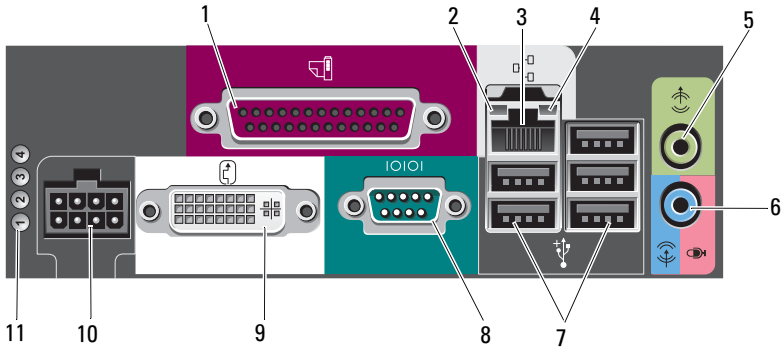

- | | | | |
|----|------------------------|----|------------------------|
| 1 | parallel connector | 2 | link-integrity light |
| 3 | network connector | 4 | network-activity light |
| 5 | line-out connector | 6 | line-in connector |
| 7 | USB 2.0 connectors (5) | 8 | serial connector |
| 9 | DVI video connector | 10 | power connector |
| 11 | diagnostic lights (4) | | |

Setting Up Your Computer



CAUTION: Before you begin any of the procedures in this section, read the safety information that shipped with your computer. For additional safety best practices information, see the Regulatory Compliance Homepage at www.dell.com/regulatory_compliance.

Quick Setup



NOTE: Some devices may not be included if you did not order them.

- 1 Connect the monitor using only one of the following cables or adapters:
 - Blue VGA cable
 - DisplayPort cable
 - DisplayPort to DVI adapter
 - White DVI cable
 - Dual monitor Y-adapter cable



NOTE: The desktop, mini-tower, and small form factor computers natively support either a VGA or a DisplayPort connection.



NOTE: The ultra small form factor computer natively supports a DVI-I connection only.

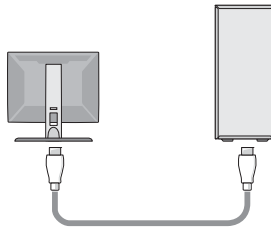
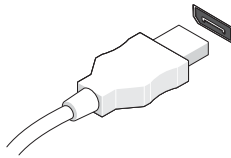
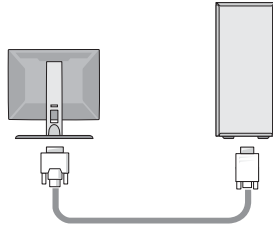
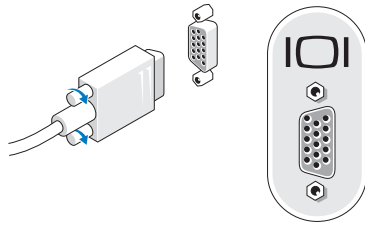

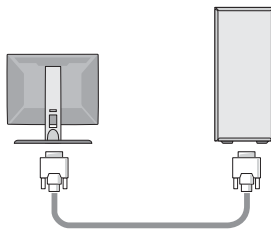
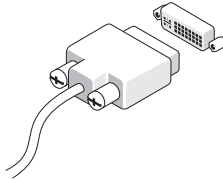
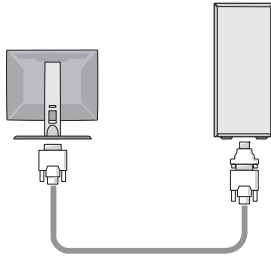
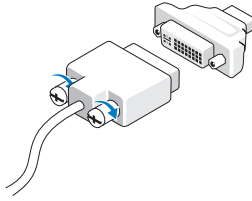

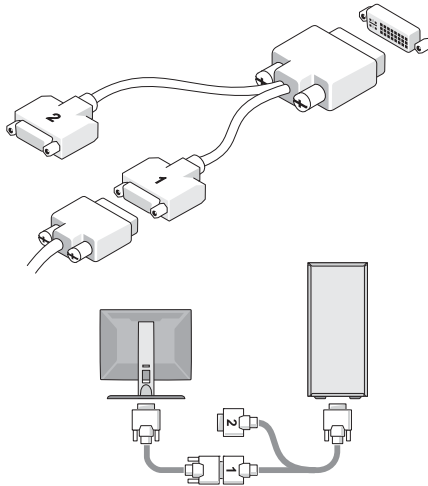
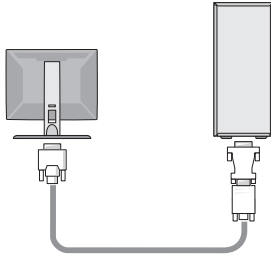
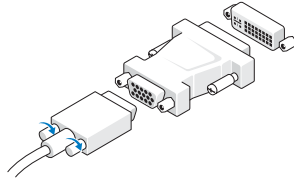

- 2 Connect a USB device, such as a keyboard or mouse.

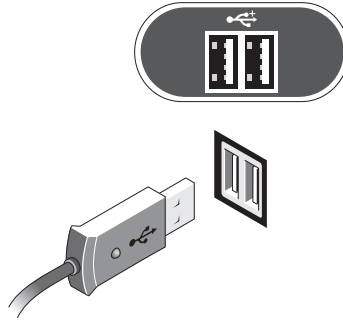

- ➔ NOTICE:** Ensure that you connect the network cable to the connector identified with the icon shown in the following illustration.

- 3 Connect the network cable.

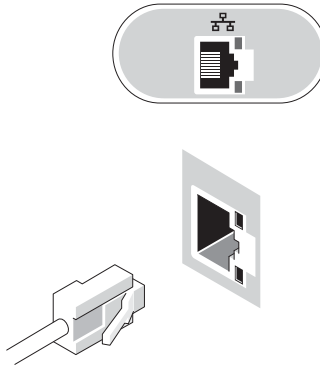

- ➔ NOTICE:** Ensure that you connect the modem to the connector identified with the icon shown in the following illustration.

- 4 Connect the modem (optional).

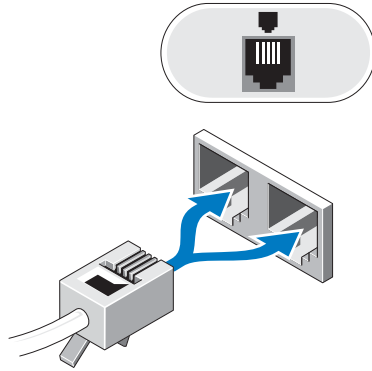

5 Connect the power cable(s).

 **NOTE:** If you are using an ultra small form factor computer, see "Connecting the AC Power Adapter (Ultra Small Form Factor Only)" on page 23.

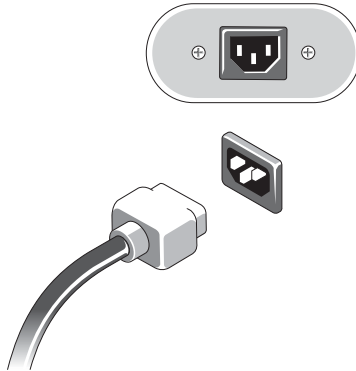

- 6 Press the power buttons on the monitor and the computer.

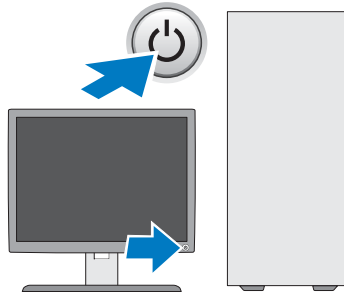

- 7 Connect to your network.

Connecting the AC Power Adapter (Ultra Small Form Factor Only)

- 1 Connect the AC power adapter to the power connector on the back of the computer. Ensure that the latch clicks into place for a secure connection.
- 2 Connect one end of the AC power cable to the power adapter.



CAUTION: If your power adapter cable has a green grounding wire, *do not permit* contact between the green grounding wire and power leads because electrical shock, fire, or damage to your computer can occur.

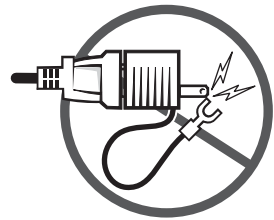

- 3 If your AC power cable has a green grounding wire for connection to an electrical outlet, connect the metal grounding connector to the grounding source (often a screw) on the outlet (see the following illustration):
 - a Loosen the grounding source.
 - b Slide the metal grounding connector behind the grounding source, and then tighten the grounding source.

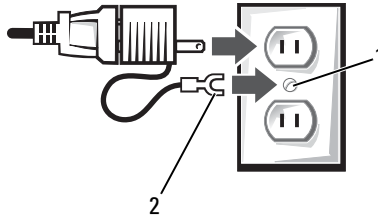

- 1 grounding source (screw)
- 2 metal ground connector

4 Connect the AC power cable to the power outlet.

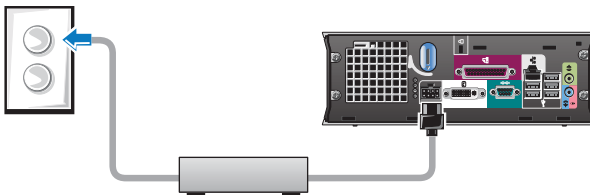

The AC power adapter has a status light that is off when the adapter is not plugged into the power outlet, and it is green or amber for the following different states:

- green light — solid green indicates that the power adapter is connected to an AC power outlet and to the computer.
- amber light — solid amber indicates that the power adapter is connected to an AC power outlet but not to the computer. The computer will not operate in this condition. Connect the AC power adapter to the computer and/or reset the power adapter by disconnecting and reconnecting the plug to the power outlet.

Ultra Small Form Factor Cable Cover (Optional)

Attaching the Cable Cover

- 1 Ensure that all external device cables are threaded through the hole in the cable cover.
- 2 Connect all device cables to the connectors on the back of the computer.
- 3 Hold the bottom of the cable cover to align the tabs with the slots on the computer's back panel.
- 4 Insert the tabs into the slots and slide the cover to align the end of the cover with the end of the chassis (see the illustration) until the cable cover is securely positioned.
- 5 Install a security device in the security cable slot (optional).

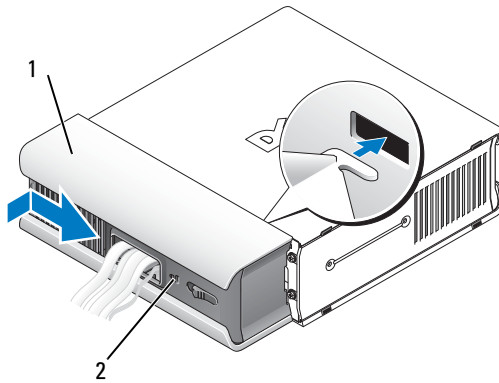

- 1 cable cover
- 2 security cable slot

Removing the Cable Cover

- 1 If a security device is installed in the security cable slot, remove the device.

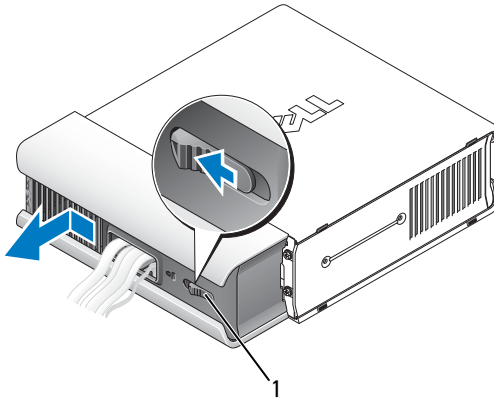

1 release button

- 2 Slide the release button, grasp the cable cover, and slide the cover sideways as shown until it stops, and then lift the cable cover up and away.

Installing Your Computer in an Enclosure

Installing your computer in an enclosure can restrict the airflow and impact your computer's performance, possibly causing it to overheat. Follow the guidelines below when installing your computer in an enclosure.

CAUTION: Before installing your computer in an enclosure, read the safety instructions that shipped with your computer.

NOTICE: The operating temperature specifications indicated in this document reflects the maximum ambient operating temperature. The room ambient temperature needs to be a consideration when you install your computer in an enclosure. For example, if the ambient room temperature is at 25°C (77°F), depending on your computer's specifications, you only have 5° to 10°C (9° to 18°F) temperature margin before you reach your computer's maximum operating temperature. For details about your computer's specifications, see "Specifications" on page 35.

- Leave a 10.2-cm (4-in) minimum clearance on all sides of the computer that have air vents to permit the airflow required for proper ventilation.
- If your enclosure has doors, the doors need to be of a type that allows at least a 30-percent airflow through the enclosure at the front and at the back.

➡ NOTICE: Do not install your computer in an enclosure that does not allow airflow. Restricting the airflow impacts your computer's performance, possibly causing it to overheat.

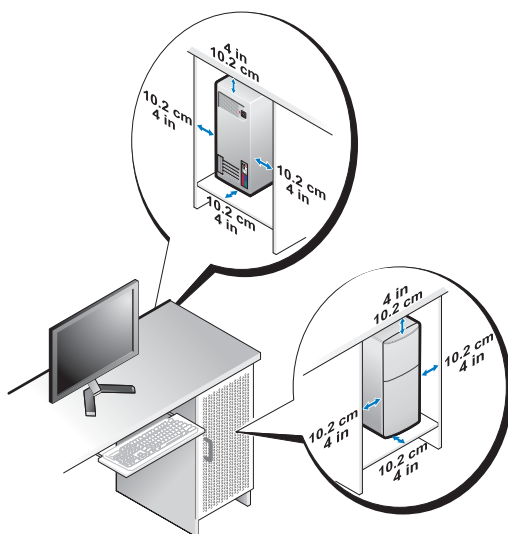

- If your computer is installed in a corner on a desk or under a desk, leave at least 5.1-cm (2-in) clearance from the back of the computer to the wall to permit the airflow required for proper ventilation.

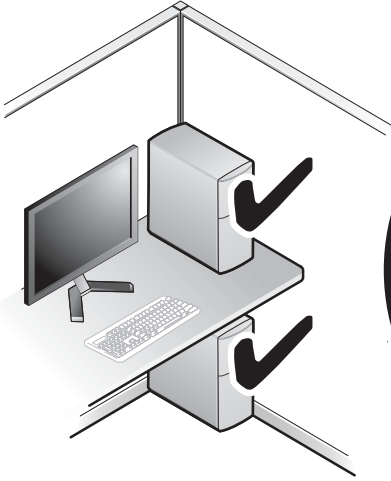

Connecting to the Internet

 **NOTE:** ISPs and ISP offerings vary by country.

To connect to the Internet, you need a modem or network connection and an Internet service provider (ISP). *If you are using a dial-up connection*, connect a telephone line to the modem connector on your computer and to the telephone wall connector before you set up your Internet connection. *If you are using a DSL or cable/satellite modem connection*, contact your ISP or cellular phone service for setup instructions.

Setting Up Your Internet Connection

To set up an Internet connection with a desktop shortcut provided by your ISP:

- 1 Save and close any open files, and exit any open programs.
- 2 Double-click the ISP icon on the Microsoft® Windows® desktop.
- 3 Follow the instructions on the screen to complete the setup.

If you do not have an ISP icon on your desktop or if you want to set up an Internet connection with a different ISP, perform the steps in the appropriate section below.

 **NOTE:** If you cannot connect to the Internet, see the *Dell Technology Guide*. If you have successfully connected in the past, the ISP might have a service outage. Contact your ISP to check the service status, or try connecting again later.

 **NOTE:** Have your ISP information ready. If you do not have an ISP, consult the **Connect to the Internet** wizard.

Microsoft® Windows Vista® Operating System

- 1 Save and close any open files, and exit any open programs.
- 2 Click the Windows Vista Start button  → **Control Panel**.
- 3 Under **Network and Internet**, click **Connect to the Internet**.
- 4 In the **Connect to the Internet** window, click either **Broadband (PPPoE)** or **Dial-up**, depending on how you want to connect:
 - Choose **Broadband** if you will use a DSL, satellite modem, cable TV modem, or Bluetooth® wireless technology connection.
 - Chose **Dial-up** if you will use a dial-up modem or ISDN.

 **NOTE:** If you do not know which type of connection to select, click **Help me choose** or contact your ISP.

- 5 Follow the instructions on the screen and use the setup information provided by your ISP to complete the setup.

Microsoft Windows® XP

- 1 Save and close any open files, and exit any open programs.
- 2 Click **Start** → **Internet Explorer** → **Connect to the Internet**.
- 3 In the next window, click the appropriate option:
 - If you do not have an ISP, click **Choose from a list of Internet service providers (ISPs)**.
 - If you have already obtained setup information from your ISP but you did not receive a setup CD, click **Set up my connection manually**.
 - If you have a setup CD, click **Use the CD I got from an ISP**.
- 4 Click **Next**.

If you selected **Set up my connection manually** in step 3, continue to step 5. Otherwise, follow the instructions on the screen to complete the setup.

 **NOTE:** If you do not know which type of connection to select, contact your ISP.

- 5 Click the appropriate option under **How do you want to connect to the Internet?**, and click **Next**.
- 6 Use the setup information provided by your ISP to complete the setup.

Transferring Information to a New Computer

Microsoft® Windows Vista® Operating System

- 1 Click the Windows Vista Start button , and then click **Transfer files and settings**→**Start Windows Easy Transfer**.
- 2 In the **User Account Control** dialog box, click **Continue**.
- 3 Click **Start a new transfer** or **Continue a transfer in progress**.
- 4 Follow the instructions provided on the screen by the Windows Easy Transfer wizard.

Microsoft Windows® XP

Windows XP provides the Files and Settings Transfer Wizard to move data from a source computer to a new computer.

You can transfer the data to the new computer over a network or serial connection, or you can store it on removable media, such as a writable CD, for transfer to the new computer.



NOTE: You can transfer information from an old computer to a new computer by directly connecting a serial cable to the input/output (I/O) ports of the two computers.

For instructions on setting up a direct cable connection between two computers, see Microsoft Knowledge Base Article #305621, titled *How to Set Up a Direct Cable Connection Between Two Computers in Windows XP*. This information may not be available in certain countries.

For transferring information to a new computer, you must run the Files and Settings Transfer Wizard.

Running the Files and Settings Transfer Wizard With the Operating System Media



NOTE: This procedure requires the *Operating System* media. This media is optional and may not be included with certain computers.

To prepare a new computer for the file transfer:

- 1 Open the Files and Settings Transfer Wizard: click **Start**→**All Programs**→**Accessories**→**System Tools**→**Files and Settings Transfer Wizard**.
- 2 When the **Files and Settings Transfer Wizard** welcome screen appears, click **Next**.
- 3 On the **Which computer is this?** screen, click **New Computer**→**Next**.
- 4 On the **Do you have a Windows XP CD?** screen, click **I will use the wizard from the Windows XP CD**→**Next**.
- 5 When the **Now go to your old computer** screen appears, go to your old or source computer. Do *not* click **Next** at this time.

To copy data from the old computer:

- 1 On the old computer, insert the Windows XP *Operating System* media.
- 2 On the **Welcome to Microsoft Windows XP** screen, click **Perform additional tasks**.
- 3 Under **What do you want to do?**, click **Transfer files and settings**→**Next**.
- 4 On the **Which computer is this?** screen, click **Old Computer**→**Next**.
- 5 On the **Select a transfer method** screen, click the transfer method you prefer.
- 6 On the **What do you want to transfer?** screen, select the items you want to transfer and click **Next**.

After the information has been copied, the **Completing the Collection Phase** screen appears.

- 7 Click **Finish**.

To transfer data to the new computer:

- 1 On the **Now go to your old computer** screen on the new computer, click **Next**.
- 2 On the **Where are the files and settings?** screen, select the method you chose for transferring your settings and files and click **Next**.

The wizard applies the collected files and settings to your new computer.

- 3 On the **Finished** screen, click **Finished**, and restart the new computer.

Running the Files and Settings Transfer Wizard Without the Operating System Media

To run the Files and Settings Transfer Wizard without the *Operating System* media, you must create a wizard disk that will allow you to create a backup image file to removable media.

To create a wizard disk, use your new computer with Windows XP and perform the following steps:

- 1 Open the Files and Settings Transfer Wizard: click **Start**→**All Programs**→**Accessories**→**System Tools**→**Files and Settings Transfer Wizard**.
- 2 When the **Files and Settings Transfer Wizard** welcome screen appears, click **Next**.
- 3 On the **Which computer is this?** screen, click **New Computer**→**Next**.
- 4 On the **Do you have a Windows XP CD?** screen, click **I want to create a Wizard Disk in the following drive**→**Next**.
- 5 Insert the removable media, such as a writable CD, and click **OK**.
- 6 When the disk creation completes and the **Now go to your old computer** message appears, *do not* click **Next**.
- 7 Go to the old computer.

To copy data from the old computer:

- 1 On the old computer, insert the wizard disk, and click **Start**→**Run**.
- 2 In the **Open** field on the **Run** window, browse to the path for **fastwiz** (on the appropriate removable media) and click **OK**.
- 3 On the **Files and Settings Transfer Wizard** welcome screen, click **Next**.
- 4 On the **Which computer is this?** screen, click **Old Computer**→**Next**.
- 5 On the **Select a transfer method** screen, click the transfer method you prefer.
- 6 On the **What do you want to transfer?** screen, select the items you want to transfer and click **Next**.

After the information has been copied, the **Completing the Collection Phase** screen appears.

- 7 Click **Finish**.

To transfer data to the new computer:

- 1** On the **Now go to your old computer** screen on the new computer, click **Next**.
- 2** On the **Where are the files and settings?** screen, select the method you chose for transferring your settings and files and click **Next**. Follow the instructions on the screen.

The wizard reads the collected files and settings and applies them to your new computer.

When all of the settings and files have been applied, the **Finished** screen appears.

- 3** Click **Finished** and restart the new computer.



NOTE: For more information about this procedure, search support.dell.com for document #154781 (*What Are The Different Methods To Transfer Files From My Old Computer To My New Dell™ Computer Using the Microsoft® Windows® XP Operating System?*).



NOTE: Access to the Dell™ Knowledge Base document may not be available in certain countries.

Specifications



NOTE: Offerings may vary by region. For more information regarding the configuration of your computer, click **Start→Help and Support** and select the option to view information about your computer.

Processor

Processor type	Intel® Core™ 2 Duo; FSB up to 1333 MHz Intel Pentium® Dual-Core; FSB up to 800 MHz Intel Celeron®; FSB up to 800 MHz
Level 2 (L2) cache	at least 512 KB pipelined-burst, eight-way set associative, writeback SRAM

System Information

Chipset	Intel Q43 Express chipset w/ICH10D
DMA channels	eight
Interrupt levels	24
BIOS chip (NVRAM)	32 Mb
Network adapter	integrated network interface capable of 10/100/1000 Mbps communication

Memory

Type	667-MHz or 800-MHz DDR2 SDRAM; non-ECC memory only
Memory connectors	
mini tower, desktop, and small form factor	four
ultra small form factor	two

Memory (continued)

Memory capacities	512-MB, 1-GB, 2-GB, 3-GB, or 4-GB non-ECC
Minimum memory	512 MB
Maximum memory	4 GB

Video

Type:

Integrated	Intel integrated video up to 256-MB video memory (shared) at total system memory of greater than 512 MB
Discrete	PCI Express x16 slot can support either a PCI Express card or a DVI graphics card (for dual-monitor support) NOTE: The ultra small form factor computer supports integrated video only.

Audio

Type	ADI 1984A high definition audio
------	---------------------------------

Expansion Bus

Bus type	PCI 2.3 PCI Express 2.0 SATA 1.0A and 2.0 eSATA USB 2.0
Bus speed	PCI: 133 MB/s PCI Express: x1-slot bidirectional speed — 250 MB/s x16-slot bidirectional speed — 8 GB/s SATA: 1.5 Gbps and 3.0 Gbps eSATA: 3.0 Gbps USB: 480 Mbps

Cards

PCI (without riser card)

mini tower	two full height cards
desktop	two low profile cards
small form factor	one half length card

PCI (with riser card)

desktop	up to two full height or half length cards one low profile card
---------	--

PCI Express x1

mini tower	one full height card
------------	----------------------

PCI Express x16 (without riser card)

mini tower	one full height card
desktop and small form factor	one low profile card

PCI Express x16 (with riser card)

desktop computer	one full height card
------------------	----------------------

NOTE: The PCI Express x16 slot is disabled when a display is connected to the built-in DisplayPort connector on a desktop, mini tower, or small form factor.

Drives

Externally accessible:

5.25-inch drive bays

mini tower	two
desktop	one

5.25-inch slimline bay

small form factor	one
-------------------	-----

5.25-inch D-module bay

ultra small form factor	one
-------------------------	-----

Drives (continued)

3.5-inch drive bay	
mini tower and desktop	one
3.5-inch slimline bay	
small form factor	one
3.5-inch D-module bay	
ultra small form factor	one
Internally accessible:	
3.5-inch SATA drive bays	
mini tower	two
desktop, small form factor, and ultra small form factor	one
Available devices:	
3.5-inch SATA hard drives	
mini tower	up to two
desktop, small form factor, and ultra small form	one
SATA DVD-ROM/ DVD+/-RW/ CD +/- RW drives	
mini tower	up to two 5.25-inch drives
desktop	one 5.25-inch drive
small form factor	one slimline drive
ultra small form factor	one D-module drive
3.5-inch floppy drive or 19-in-1 Media Card Reader	
mini tower	one
desktop	one
small form factor	one slimline drive
ultra small form factor	one D-module floppy drive

Connectors

External connectors:

Audio

back panel two connectors for line-in/ microphone and line-out

front panel two front-panel connectors for headphones and microphone

eSATA

one 7-pin connector

NOTE: The ultra small form factor computer does not have an eSATA connector.

Network adapter

one RJ45 connector

Parallel

one 25-pin connector (bidirectional)

Serial

one 9-pin connector; 16550C-compatible

USB

front panel two

back panel six

NOTE: The ultra small form factor has five USB connectors on the back panel.

NOTE: All the USB connectors are USB 2.0 compatible.

Video

mini tower, desktop, and small form factor 15-hole VGA connector
20-pin DisplayPort connector

ultra small form factor 28-pin DVI-I connector

System board connectors:

PCI

mini tower and desktop two connectors

small form factor one connector

connector size 120 pins

connector data width (maximum) 32 bits

Connectors *(continued)*

PCI Express x1

mini tower	one connector
connector size	36 pins
connector data width (maximum)	1 PCI Express lane

PCI Express x16

mini tower, desktop, and small form factor	one connector
connector size	164 pins
connector data width (maximum)	16 PCI Express lanes

Serial ATA

mini tower	four connectors
desktop and small form factor	two connectors
ultra small form factor	one connector
connector size	7-pin connector

Memory

mini tower, desktop, and small form factor	four connectors
ultra small form factor	two connectors
connector size	240 pins

Internal USB device

mini tower, desktop, and small form factor	one 10-pin connector (supports two USB ports)
---	--

Floppy drive

mini tower and desktop	one 34-pin connector
small form factor	one 26-pin slim connector

Connectors (continued)

Processor fan	
mini tower, desktop, and small form factor	one 5-pin connector
ultra small form factor	two 5-pin connectors
Hard-drive fan	
small form factor	one 5-pin connector
ultra small form factor	one 3-pin slim connector
Front panel control	one 40-pin connector
Processor	one 775-pin connector
Power 12V	one 4-pin connector
Power	one 24-pin connector

Controls and Lights

Front of computer:

Power button	push button
Power light	green light — Blinking green in sleep state; solid green for power-on state. amber light — The blinking amber indicates a problem with the system board. A solid amber light when the computer does not start indicates that the system board cannot start initialization. This could be a system board or a power supply problem (see "Power Problems" on page 46).
Drive activity light	green light — A blinking green light indicates that the computer is reading data from or writing data to the SATA hard drive or CD/DVD.
Network connectivity light	green light — A good connection exists between the network and the computer. off (no light) — The computer is not detecting a physical connection to the network.

Controls and Lights *(continued)*

Diagnostic lights	four lights
-------------------	-------------

NOTE: For the ultra small form factor computer, the diagnostic lights are on the back panel. See "Ultra Small Form Factor — Back View" on page 15.

Back of the computer:

Link integrity light on integrated network adapter	<p>green light — A good 10 Mbps connection exists between the network and the computer.</p> <p>orange light — A good 100 Mbps connection exists between the network and the computer.</p> <p>yellow light — A good 1000 Mbps connection exists between the network and the computer.</p> <p>off (no light) — The computer is not detecting a physical connection to the network.</p>
Network activity light on integrated network adapter	yellow light — A blinking yellow light indicates that network activity is present.

Power

DC power supply:

Wattage	
mini tower	305W non-EPA; 255W EPA
desktop	255 W
small form factor	235 W
ultra small form factor	220 W
Maximum heat dissipation (MHD)	
mini tower	1041 BTU/hr
desktop	955 BTU/hr
small form factor	938 BTU/hr
ultra small form factor	751 BTU/hr

NOTE: Heat dissipation is calculated by using the power supply wattage rating.

Power (continued)

Voltage (see the safety information that shipped with your computer for important voltage setting information)	
mini tower	115/230 VAC, 50/60 Hz, 3.6/1.8 A
desktop	115/230 VAC, 50/60 Hz, 4.0/2.0 A
small form factor	115/230 VAC, 50/60 Hz, 3.5/1.8 A
ultra small form factor	12 VDC, 18 A
Coin-cell battery	3-V CR2032 lithium coin cell

Physical

Height

mini tower	36.2 cm (14.2 inches)
desktop	11.4 cm (4.5 inches)
small form factor	9.26 cm (3.65 inches)
ultra small form factor	26.4 cm (10.375 inches)

Width

mini tower	17.0 cm (6.7 inches)
desktop	39.9 cm (15.7 inches)
small form factor	31.37 cm (12.35 inches)
ultra small form factor	8.9 cm (3.5 inches)

Depth

mini tower	43.5 cm (17.1 inches)
desktop	35.3 cm (13.9 inches)
small form factor	34.03 cm (13.40 inches)
ultra small form factor	without cable cover — 25.3 cm (9.95 inches) with standard cable cover — 33 cm (13 inches) with extend cable cover — 36.1 cm (14.2 inches)

Physical (continued)

Weight

mini tower	12.7 kg (28.0 lb)
desktop	10.4 kg (23 lb)
small form factor	7.4 kg (16.4 lb)
ultra small form factor	without cable cover — 4.5 kg (10 lb) with standard cable cover — 4.9 kg (10.8 lb) with extend cable cover — 4.9 kg (10.8 lb)

Environmental

Temperature:

Operating 10° to 35°C (50° to 95°F)

Storage -40° to 65°C (-40° to 149°F)

Relative humidity
(noncondensing)

operating: 20% to 80% (maximum wet bulb
temperature: 29°C)

storage: 5% to 95% (maximum wet bulb temperature:
38°C)

Maximum vibration:

Operating 5 to 350 Hz at 0.0002 G²/Hz

Storage 5 to 500 Hz at 0.001 to 0.01 G²/Hz

Maximum shock:

Operating 40 G +/- 5% with pulse duration of 2 msec +/- 10%
(equivalent to 20 in/sec [51 cm/sec])

Storage 105 G +/- 5% with pulse duration of 2 msec +/- 10%
(equivalent to 50 in/sec [127 cm/sec])

Altitude:

Operating -15.2 to 3048 m (-50 to 10,000 ft)

Storage -15.2 to 10,668 m (-50 to 35,000 ft)

Airborne contaminant level

G2 or lower as defined by ISA-S71.04-1985

Troubleshooting



CAUTION: Before you begin any of the procedures in this section, read the safety information that shipped with your computer. For additional safety best practices information, see the Regulatory Compliance Homepage at www.dell.com/regulatory_compliance.



CAUTION: Always unplug your computer from the electrical outlet before opening the cover.



NOTE: For detailed troubleshooting information, including responding to system messages, see your *Service Manual* on support.dell.com.

Using the Hardware Troubleshooter

To start the Hardware Troubleshooter to resolve hardware incompatibility:

Windows Vista[®]:

- 1 Click the Windows Vista Start button , and click **Help and Support**.
- 2 Type `hardware troubleshooter` in the search field and press <Enter> to start the search.
- 3 In the search results, select the option that best describes the problem and follow the remaining troubleshooting steps.

Windows[®] XP:

- 1 Click **Start** → **Help and Support**.
- 2 Type `hardware troubleshooter` in the search field and press <Enter> to start the search.
- 3 In the **Fix a Problem** section, click **Hardware Troubleshooter**.
- 4 In the **Hardware Troubleshooter** list, select the option that best describes the problem and click **Next** to follow the remaining troubleshooting steps.

Tips

- If a device does not work, ensure that the device is properly connected.
- If you added or removed a part before the problem started, review the installation procedures and ensure that the part is correctly installed.
- If an error message appears on the screen, write down the exact message. This message may help support personnel to diagnose and fix the problem(s).
- If an error message occurs in a program, see the program documentation.

Power Problems



CAUTION: Before you begin any of the procedures in this section, read the safety information that shipped with your computer. For additional safety best practices information, see the Regulatory Compliance Homepage at www.dell.com/regulatory_compliance.

IF THE POWER LIGHT IS OFF — The computer is either turned off or is not receiving power.

- Reseat the power cable in the power connector on the back of the computer and the electrical outlet.
- Bypass power strips, power extension cables, and other power protection devices to verify that the computer turns on properly.
- Ensure that any power strips being used are plugged into an electrical outlet and are turned on.
- Ensure that the electrical outlet is working by testing it with another device, such as a lamp.
- Ensure that the main power cable and front panel cable are securely connected to the system board.

IF THE POWER LIGHT IS GREEN AND THE COMPUTER IS NOT RESPONDING —

- Ensure that the display is connected and powered on.
- If the display is connected and powered on, see (see your *Service Manual* at support.dell.com).

IF THE POWER LIGHT IS BLINKING GREEN — The computer is in sleep mode. Press a key on the keyboard, move the mouse, or press the power button to resume normal operation.

IF THE POWER LIGHT IS BLINKING AMBER — The computer is receiving electrical power, a device might be malfunctioning or incorrectly installed.

- Remove and then reinstall all memory modules.
- Remove and then reinstall any expansion cards, including graphics cards.

IF THE POWER LIGHT IS STEADY AMBER — There is a power problem, a device may be malfunctioning or incorrectly installed.

- Ensure that the processor power cable is securely connected to the system board power connector (see your *Service Manual* at support.dell.com).
- Ensure that the main power cable and the front panel cable are securely connected to the system board connector.

ELIMINATE INTERFERENCE — Some possible causes of interference are:

- Power, keyboard, and mouse extension cables
- Too many devices connected to the same power strip
- Multiple power strips connected to the same electrical outlet

Memory Problems



CAUTION: Before you begin any of the procedures in this section, read the safety information that shipped with your computer. For additional safety best practices information, see the Regulatory Compliance Homepage at www.dell.com/regulatory_compliance.

IF YOU RECEIVE AN INSUFFICIENT MEMORY MESSAGE —

- Save and close any open files and exit any open programs you are not using to see if that resolves the problem.
- See the software documentation for minimum memory requirements. If necessary, install additional memory.
- Reseat the memory modules to ensure that your computer is successfully communicating with the memory.
- Run the Dell Diagnostics (see "Dell Diagnostics" on page 50).

IF YOU EXPERIENCE OTHER MEMORY PROBLEMS —

- Reseat the memory modules to ensure that your computer is successfully communicating with the memory.
- Ensure that you are following the memory installation guidelines.

- Ensure that the memory you are using is supported by your computer. For more information about the type of memory supported by your computer, see "Memory" on page 35.
- Run the Dell Diagnostics (see "Dell Diagnostics" on page 50).

Lockups and Software Problems

The computer does not start up

ENSURE THAT THE POWER CABLE IS FIRMLY CONNECTED TO THE COMPUTER AND TO THE ELECTRICAL OUTLET

A program stops responding

END THE PROGRAM —

- 1 Press <Ctrl><Shift><Esc> simultaneously to access the Task Manager, and click the **Applications** tab.
- 2 Click to select the program that is no longer responding, and click **End Task**.

A program crashes repeatedly



NOTE: Most software includes installation instructions in its documentation or on a floppy disk, CD, or DVD.

CHECK THE SOFTWARE DOCUMENTATION — If necessary, uninstall and then reinstall the program.

A program is designed for an earlier Microsoft® Windows® operating system

RUN THE PROGRAM COMPATIBILITY WIZARD —

Windows Vista:

- 1 Click **Start**  → **Control Panel** → **Programs** → **Use an older program with this version of Windows**.
- 2 In the welcome screen, click **Next**.
- 3 Follow the instructions on the screen.

Windows XP:

The Program Compatibility Wizard configures a program so that it runs in an environment similar to non-XP operating system environments.

- 1 Click **Start**→**All Programs**→**Accessories**→**Program Compatibility Wizard**→**Next**.
- 2 Follow the instructions on the screen.

A solid blue screen appears

TURN THE COMPUTER OFF — If you are unable to get a response by pressing a key on your keyboard or moving your mouse, press and hold the power button for at least 6 seconds (until the computer turns off), and then restart your computer.

Other software problems

CHECK THE SOFTWARE DOCUMENTATION OR CONTACT THE SOFTWARE MANUFACTURER FOR TROUBLESHOOTING INFORMATION —

- Ensure that the program is compatible with the operating system installed on your computer.
- Ensure that your computer meets the minimum hardware requirements needed to run the software. See the software documentation for information.
- Ensure that the program is installed and configured properly.
- Verify that the device drivers do not conflict with the program.
- If necessary, uninstall and then reinstall the program.

Dell Technical Update Service



- The Dell Technical Update service provides proactive e-mail notification of software and hardware updates for your computer. To enroll for the Dell Technical Update service, go to support.dell.com/technicalupdate.

Dell Diagnostics



CAUTION: Before you begin any of the procedures in this section, read the safety information that shipped with your computer. For additional safety best practices information, see the Regulatory Compliance Homepage at www.dell.com/regulatory_compliance.

Starting the Dell Diagnostics From Your Hard Drive

- 1 Ensure that the computer is connected to a working electrical outlet.
- 2 Turn on (or restart) your computer.
- 3 When the DELL™ logo appears, press <F12> immediately. Select **Diagnostics** from the start menu and press <Enter>.
 **NOTE:** If you wait too long and the operating system logo appears, continue to wait until you see the Microsoft® Windows® desktop, and then shut down your computer and try again.
 **NOTE:** If you see a message stating that no diagnostics utility partition has been found, run the Dell Diagnostics from the *Drivers and Utilities* media.
- 4 Press any key to start the Dell Diagnostics from the diagnostics utility partition on your hard drive, and follow the instructions on the screen.

Starting the Dell Diagnostics From the Dell *Drivers and Utilities* Media



NOTE: The Dell *Drivers and Utilities* media is optional and may not ship with your computer.

- 1 Insert the *Drivers and Utilities* media.
- 2 Shut down and restart the computer.

When the DELL logo appears, press <F12> immediately.



NOTE: If you wait too long and the operating system logo appears, continue to wait until you see the Microsoft® Windows® desktop; then, shut down your computer and try again.



NOTE: The next steps change the boot sequence for one time only. On the next start-up, the computer starts according to the devices specified in the system setup program.

- 3 When the boot device list appears, highlight **CD/DVD/CD-RW** and press <Enter>.

- 4** Select the **Boot from CD-ROM** option from the menu that appears and press <Enter>.
- 5** Type 1 to start the CD menu and press <Enter> to proceed.
- 6** Select **Run the 32 Bit Dell Diagnostics** from the numbered list. If multiple versions are listed, select the version that is appropriate for your computer.
- 7** When the Dell Diagnostics **Main Menu** appears, select the test that you want to run, and follow the instructions on the screen.

Reinstalling Software

Drivers

Identifying Drivers

- 1 Locate the list of devices for your computer.

Microsoft® Windows Vista®:

- a Click the Windows Vista Start button™ , and right-click **Computer**.
- b Click **Properties**→**Device Manager**.



NOTE: The **User Account Control** window may appear. If you are an administrator on the computer, click **Continue**; otherwise, contact your administrator to continue.

Microsoft Windows® XP:

- a Click **Start**→**Control Panel**.
 - b Under **Pick a Category**, click **Performance and Maintenance**, and click **System**.
 - c In the **System Properties** window, click the **Hardware** tab, and click **Device Manager**.
- 2 Scroll down the list to see if any device has an exclamation point (a yellow circle with a [!]) on the device icon.

If an exclamation point is next to the device name, you may need to reinstall the driver or install a new driver (see "Reinstalling Drivers and Utilities" on page 54).



Reinstalling Drivers and Utilities



NOTICE: The Dell Support website at support.dell.com and your *Drivers and Utilities* media provide approved drivers for Dell™ computers. If you install drivers obtained from other sources, your computer might not work correctly.

Returning to a Previous Device Driver Version

Windows Vista:

- 1 Click the Windows Vista Start button , and right-click **Computer**.
- 2 Click **Properties**→**Device Manager**.
 **NOTE:** The **User Account Control** window may appear. If you are an administrator on the computer, click **Continue**; otherwise, contact your administrator to enter the Device Manager.
- 3 Right-click the device for which the new driver was installed and click **Properties**.
- 4 Click the **Drivers** tab→**Roll Back Driver**.

Windows XP:

- 1 Click **Start**→**My Computer**→**Properties**→**Hardware**→**Device Manager**.
- 2 Right-click the device for which the new driver was installed and click **Properties**.
- 3 Click the **Drivers** tab→**Roll Back Driver**.

If Device Driver Rollback does not resolve the problem, use System Restore (see "Restoring Your Operating System" on page 56) to return your computer to the operating state that existed before you installed the new driver.

Using the Drivers and Utilities Media

If using Device Driver Rollback or System Restore (see "Restoring Your Operating System" on page 56) does not resolve the problem, reinstall the driver from your *Drivers and Utilities* media.

- 1 With the Windows desktop displayed, insert your *Drivers and Utilities* media.
If this is your first time using the *Drivers and Utilities* media, go to step 2. If not, go to step 5.

- 2 When the *Drivers and Utilities* media installation program starts, follow the prompts on the screen.



NOTE: In most cases, the *Drivers and Utilities* program starts running automatically. If it does not, start Windows Explorer, click your media drive directory to display the media contents, and then double-click the `autorcd.exe` file.

- 3 When the **InstallShield Wizard Complete** window appears, remove the *Drivers and Utilities* media and click **Finish** to restart the computer.
- 4 When you see the Windows desktop, reinsert the *Drivers and Utilities* media.
- 5 At the **Welcome Dell System Owner** screen, click **Next**.

The drivers that are used by your computer are automatically displayed in the **My Drivers—The ResourceCD has identified these components in your system** window.

- 6 Click the driver that you want to reinstall and follow the instructions on the screen.

If a particular driver is not listed, then either that driver is not required by your operating system, or you must find the drivers that came with the specific device.

Manually Reinstalling Drivers

After extracting the driver files to your hard drive as described in the previous section:

Microsoft Windows Vista:

- 1 Click the Windows Vista Start button , and right-click **Computer**.
- 2 Click **Properties**→**Device Manager**.



NOTE: The **User Account Control** window appears. If you are an administrator on the computer, click **Continue**; otherwise, contact your administrator to enter the Device Manager.

- 3 Double-click the type of device for which you are installing the driver (for example, **Audio** or **Video**).
- 4 Double-click the name of the device for which you are installing the driver.
- 5 Click the **Driver** tab→**Update Driver**→**Browse my computer for driver software**.

- 6 Click **Browse** and browse to the location to which you previously copied the driver files.
- 7 Click the name of the driver→**OK**→**Next**.
- 8 Click **Finish** and restart your computer.

Microsoft Windows XP:

- 1 Click the **Start** →**Settings** →**Control Panel**.
- 2 Double click the **System** icon and then click the **Hardware** tab.
- 3 Click **Device Manager**.
 **NOTE:** If you are an administrator on the computer, **Device Manager** lets you proceed; otherwise, contact your administrator to enter the **Device Manager**.
- 4 Click the + symbol next to device for which you are installing the driver (for example, **Audio** or **Video**).
- 5 Double-click the name of the device for which you are installing the driver.
- 6 Click the **Driver** →**Update Driver**→**Install from a list or specific location(Advanced)** and then click **Next**.
- 7 Click **Browse** and browse to the location to which you previously copied the driver files.
- 8 Click the name of the driver→**OK**→**Next**.
- 9 Click **Finish** and restart your computer.

Restoring Your Operating System

You can restore your operating system in the following ways:

- Microsoft Windows System Restore returns your computer to an earlier operating state without affecting data files. Use System Restore as the first solution for restoring your operating system and preserving data files.
- Dell Factory Image Restore (available in Windows Vista) returns your hard drive to the operating state it was in when you purchased the computer. The program permanently deletes all data on the hard drive and removes any programs installed after you received the computer.
- If you received the *Operating System* media with your computer, you can use it to restore your operating system. However, using the *Operating System* media also deletes all data on the hard drive.

Using Microsoft® Windows® System Restore



NOTE: The procedures in this document were written for the Windows default view, so they may not apply if you set your Dell™ computer to the Windows Classic view.

Starting System Restore

Windows Vista:

- 1 Click Start .
- 2 In the Start Search box, type *System Restore* and press <Enter>.



NOTE: The **User Account Control** window may appear. If you are an administrator on the computer, click **Continue**; otherwise, contact your administrator to continue the desired action.

- 3 Click **Next** and follow the remaining prompts on the screen.

Windows XP:



NOTICE: Before you restore the computer to an earlier operating state, save and close any open files and exit any open programs. Do not alter, open, or delete any files or programs until the system restoration is complete.

- 1 Click **Start**→**All Programs**→**Accessories**→**System Tools**→**System Restore**.
- 2 Click either **Restore my computer to an earlier time** or **Create a restore point**.
- 3 Click **Next** and follow the remaining on-screen prompts.

Undoing the Last System Restore



NOTICE: Before you undo the last system restore, save and close all open files and exit any open programs. Do not alter, open, or delete any files or programs until the system restoration is complete.

Windows Vista:

- 1 Click Start .
- 2 In the Start Search box, type *System Restore* and press <Enter>.
- 3 Click **Undo my last restoration** and click **Next**.

Windows XP:

- 1 Click **Start**→**All Programs**→**Accessories**→**System Tools**→**System Restore**.
- 2 Click **Undo my last restoration** and click **Next**.

Using Dell Factory Image Restore



NOTICE: Using Dell Factory Image Restore permanently deletes all data (for example, documents, spreadsheets, e-mail messages, digital photos, and music files) on the hard drive and removes any programs or drivers installed after you received your computer. If possible, back up the data before using these options. Use Dell Factory Image Restore only if System Restore did not resolve your operating system problem.



NOTE: Dell Factory Image Restore may not be available in certain countries or on certain computers.

Dell Factory Image Restore (Windows Vista Only)

- 1 Turn on the computer.
- 2 When the Dell logo appears, press <F8> several times to access the Vista Advanced Boot Options Window.
- 3 Select **Repair Your Computer**.
The System Recovery Options window appears.
- 4 Select a keyboard layout and click **Next**.
- 5 To access the recovery options, log on as a local user.
- 6 To access the command prompt, type `administrator` in the User name field, then click **OK**.
- 7 Click **Dell Factory Image Restore**.



NOTE: Depending upon your configuration, you may need to select **Dell Factory Tools**, then **Dell Factory Image Restore**.

- 8 On the **Dell Factory Image Restore** welcome screen, click **Next**.
The **Confirm Data Deletion** screen appears.



NOTICE: If you do not want to proceed with Factory Image Restore, click **Cancel**.

- 9 Click the checkbox to confirm that you want to continue reformatting the hard drive and restoring the system software to the factory condition, then click **Next**.

The restore process begins and may take 5 or more minutes to complete. A message appears when the operating system and factory-installed applications have been restored to factory condition.

- 10 Click **Finish** to restart the computer.

Dell PC Restore (Windows XP Only)

- 1 Turn on the computer.

During the boot process, a blue bar with www.dell.com appears at the top of the screen.

- 2 Immediately upon seeing the blue bar, press <Ctrl><F11>.

If you do not press <Ctrl><F11> in time, let the computer finish starting, and then restart the computer again.

- 3 Click **Restore** and click **Confirm**.

The restore process takes approximately 6 to 10 minutes to complete.

- 4 When prompted, click **Finish** to restart the computer.

- 5 When prompted, click **Yes**.

The computer restarts. Because the computer is restored to its original operating state, the screens that appear are the same ones that appeared the first time the computer was turned on.

- 6 Click **Next**.

The System Restore screen appears and the computer restarts.

- 7 After the computer restarts, click **OK**.

Windows XP: Removing Dell PC Restore:

- ➔ **NOTICE:** Removing Dell PC Restore from the hard drive permanently deletes the PC Restore utility from your computer. After you have removed Dell PC Restore, you will not be able to use it to restore your computer operating system.

It is recommended that you *do not* remove PC Restore from your computer, even to gain additional hard drive space. If you remove PC Restore from the hard drive, you will not be able to return your computer operating system to its original state.

- 1 Log on to the computer as a local administrator.
- 2 In Microsoft Windows Explorer, go to `c:\dell\utilities\DSR`.
- 3 Double-click the filename `DSRIRRemv2.exe`.



NOTE: If the partition for PC Restore does not exist on your computer hard drive, a message appears stating that the partition was not found. Click **Quit**; there is no partition to delete.

- 4 Click **OK** to remove the PC Restore partition on the hard drive.
- 5 Click **Yes** when a confirmation message appears.
The PC Restore partition is deleted and the newly available disk space is added.
- 6 Right-click **Local Disk (C)** in Windows Explorer, click **Properties**, and verify that the additional disk space is available.
- 7 Click **Finish** to close the **PC Restore Removal** window and restart the computer.

Using the Operating System Media

Before reinstalling the operating system, try the following:

- Windows Device Driver Rollback (see "Returning to a Previous Device Driver Version" on page 54)
- Microsoft System Restore (see "Dell PC Restore (Windows XP Only)" on page 59)

- ➔ **NOTICE:** Before performing the installation, back up all data files from your primary hard drive to another media. For conventional hard drive configurations, the primary hard drive is the first drive detected by the computer.

To reinstall Windows, you need the Dell™ *Operating System* media and the *Dell Drivers and Utilities* media. The *Dell Drivers and Utilities* media contains drivers that were installed at the time you ordered your computer. Use the *Dell Drivers and Utilities* media to load any required drivers.

 **NOTE:** Depending on the region from which you ordered your computer, or whether you requested the media, the *Dell Drivers and Utilities* media and *Dell Operating System* media may not ship with your computer.

Reinstalling Windows

The reinstallation process can take 1 to 2 hours to complete.

- 1 Save and close any open files and exit any open programs.
- 2 Insert the *Operating System* media.
- 3 If the `Install Windows` message appears, click **Exit**.
- 4 Restart the computer.

When the DELL logo appears, press <F12> immediately.

 **NOTE:** If you wait too long and the operating system logo appears, continue to wait until you see the Microsoft® Windows® desktop; then, shut down your computer and try again.

 **NOTE:** The next steps change the boot sequence for one time only. On the next start-up, the computer boots according to the devices specified in the system setup program.

- 5 When the boot device list appears, highlight **CD/DVD/CD-RW Drive** and press <Enter>.
- 6 Press any key to **Boot from CD-ROM**, and follow the instructions on the screen to complete the installation.
- 7 Reinstall the device drivers, virus protection program, and other software.

Finding Information



NOTE: Some features or media may be optional and may not ship with your computer. Some features or media may not be available in certain countries.



NOTE: Additional information may ship with your computer.

Document/Media/Label	Contents
<p>Service Tag/Express Service Code</p> <p>The <i>Service Tag/Express Service Code</i> is located on your computer.</p>	<ul style="list-style-type: none"> • Use the Service Tag to identify your computer when you use support.dell.com or contact support • Enter the Express Service Code to direct your call when contacting support <p>NOTE: Your Service Tag/Express Service Code is located on your computer.</p>
<p>Drivers and Utilities Media</p> <p>The <i>Drivers and Utilities</i> media is a CD or DVD that may have shipped with your computer.</p>	<ul style="list-style-type: none"> • A diagnostic program for your computer • Drivers for your computer <p>NOTE: Drivers and documentation updates can be found at support.dell.com.</p> <ul style="list-style-type: none"> • Desktop System Software (DSS) • Readme files <p>NOTE: Readme files may be included on your media to provide last-minute updates about technical changes to your computer or advanced technical-reference material for technicians or experienced users.</p>
<p>Operating System Media</p> <p>The <i>Operating System</i> media is a CD or DVD that may have shipped with your computer.</p>	<p>Reinstall your operating system</p>

Document/Media/Label	Contents
<p>Safety, Regulatory, Warranty, and Support Documentation</p> <p>This type of information may have shipped with your computer. For additional safety best practices information, see the Regulatory Compliance Homepage at www.dell.com/regulatory_compliance.</p>	<ul style="list-style-type: none"> • Warranty information • Terms and Conditions (U.S. only) • Safety instructions • Regulatory information • Ergonomics information • End User License Agreement
<p>Service Manual</p> <p>The <i>Service Manual</i> for your computer can be found at support.dell.com.</p>	<ul style="list-style-type: none"> • How to remove and replace parts • How to configure system settings • How to troubleshoot and solve problems
<p>Dell Technology Guide</p> <p>The <i>Dell Technology Guide</i> is available at support.dell.com.</p>	<ul style="list-style-type: none"> • About your operating system • Using and maintaining devices • Understanding technologies such as RAID, Internet, Bluetooth® wireless technology, e-mail, networking, and more
<p>Microsoft® Windows® License Label</p> <p>Your Microsoft Windows License is located on your computer.</p>	<ul style="list-style-type: none"> • Provides your operating system product key

Getting Help

Obtaining Assistance

 **CAUTION:** If you need to remove the computer cover, first disconnect the computer power and modem cables from all electrical outlets. Follow the safety instructions that shipped with your computer.

If you experience a problem with your computer, you can complete the following steps to diagnose and troubleshoot the problem:

- 1 See "When the Dell Diagnostics Main Menu appears, select the test that you want to run, and follow the instructions on the screen." on page 51 for information and procedures that pertain to the problem your computer is experiencing.
- 2 See "Dell Diagnostics" on page 50 for procedures on how to run Dell Diagnostics.
- 3 Fill out the "Diagnostics Checklist" on page 70.
- 4 Use Dell's extensive suite of online services available at Dell Support (support.dell.com) for help with installation and troubleshooting procedures. See "Online Services" on page 66 for a more extensive list of Dell Support online.
- 5 If the preceding steps have not resolved the problem, see "Contacting Dell" on page 71.

 **NOTE:** Call Dell Support from a telephone at or near the affected computer so that the support staff can assist you with any necessary procedures.

 **NOTE:** Dell's Express Service Code system may not be available in all countries.

When prompted by Dell's automated telephone system, enter your Express Service Code to route the call directly to the proper support personnel. If you do not have an Express Service Code, open the **Dell Accessories** folder, double-click the **Express Service Code** icon, and follow the directions.

For instructions on using the Dell Support, see "Technical Support and Customer Service" on page 66.

 **NOTE:** Some of the following services are not always available in all locations outside the continental U.S. Call your local Dell representative for information on availability.

Technical Support and Customer Service

Dell's support service is available to answer your questions about Dell™ hardware. Our support staff uses computer-based diagnostics to provide fast, accurate answers.

To contact Dell's support service, see "Before You Call" on page 69, and then see the contact information for your region or go to support.dell.com.

DellConnect™

DellConnect is a simple online access tool that allows a Dell service and support associate to access your computer through a broadband connection, diagnose your problem and repair it all under your supervision. For more information, go to support.dell.com and click **DellConnect**.

Online Services

You can learn about Dell products and services at the following websites:

www.dell.com

www.dell.com/ap (Asian/Pacific countries only)

www.dell.com/jp (Japan only)

www.euro.dell.com (Europe only)

www.dell.com/la (Latin American and Caribbean countries)

www.dell.ca (Canada only)

You can access Dell Support through the following websites and e-mail addresses:

- Dell Support websites:
support.dell.com
support.jp.dell.com (Japan only)
support.euro.dell.com (Europe only)

- Dell Support e-mail addresses:
mobile_support@us.dell.com
support@us.dell.com
la-techsupport@dell.com (Latin America and Caribbean countries only)
apsupport@dell.com (Asian/Pacific countries only)
- Dell Marketing and Sales e-mail addresses:
apmarketing@dell.com (Asian/Pacific countries only)
sales_canada@dell.com (Canada only)
- Anonymous file transfer protocol (FTP):
ftp.dell.com – log in as user `anonymous`, and use your e-mail address as your password

AutoTech Service

Dell's automated support service—AutoTech—provides recorded answers to the questions most frequently asked by Dell customers about their laptop and desktop computers.

When you call AutoTech, use your touch-tone telephone to select the subjects that correspond to your questions. For the telephone number to call for your region, see "Contacting Dell" on page 71.

Automated Order-Status Service

To check on the status of any Dell products that you have ordered, you can go to **support.dell.com**, or you can call the automated order-status service. A recording prompts you for the information needed to locate and report on your order. For the telephone number to call for your region, see "Contacting Dell" on page 71.

Problems With Your Order

If you have a problem with your order, such as missing parts, wrong parts, or incorrect billing, contact Dell for customer assistance. Have your invoice or packing slip available when you call. For the telephone number to call for your region, see "Contacting Dell" on page 71.

Product Information

If you need information about additional products available from Dell, or if you would like to place an order, visit the Dell website at www.dell.com. For the telephone number to call for your region or to speak to a sales specialist, see "Contacting Dell" on page 71.

Returning Items for Warranty Repair or Credit

Prepare all items being returned, whether for repair or credit, as follows:

- 1** Call Dell to obtain a Return Material Authorization Number, and write it clearly and prominently on the outside of the box.

For the telephone number to call for your region, see "Contacting Dell" on page 71. Include a copy of the invoice and a letter describing the reason for the return.

- 2** Include a copy of the Diagnostics Checklist (see "Diagnostics Checklist" on page 70), indicating the tests that you have run and any error messages reported by the Dell Diagnostics (see "Contacting Dell" on page 71).
- 3** Include any accessories that belong with the item(s) being returned (power cables, software floppy disks, guides, and so on) if the return is for credit.
- 4** Pack the equipment to be returned in the original (or equivalent) packing materials.

You are responsible for paying shipping expenses. You are also responsible for insuring any product returned, and you assume the risk of loss during shipment to Dell. Collect On Delivery (C.O.D.) packages are not accepted.

Returns that are missing any of the preceding requirements will be refused at Dell's receiving dock and returned to you.

Before You Call



NOTE: Have your Express Service Code ready when you call. The code helps Dell's automated-support telephone system direct your call more efficiently. You may also be asked for your Service Tag (located on the back or bottom of your computer).

Remember to fill out the Diagnostics Checklist (see "Diagnostics Checklist" on page 70). If possible, turn on your computer before you call Dell for assistance and call from a telephone at or near the computer. You may be asked to type some commands at the keyboard, relay detailed information during operations, or try other troubleshooting steps possible only at the computer itself. Ensure that the computer documentation is available.



CAUTION: Before you begin any of the procedures in this section, read the safety information that shipped with your computer. For additional safety best practices information, see the Regulatory Compliance Homepage at www.dell.com/regulatory_compliance.

Diagnostics Checklist

Name:

Date:

Address:

Phone number:

Service Tag (bar code on the back or bottom of the computer):

Express Service Code:

Return Material Authorization Number (if provided by Dell support technician):

Operating system and version:

Devices:

Expansion cards:

Are you connected to a network? Yes No

Network, version, and network adapter:

Programs and versions:

See your operating system documentation to determine the contents of the system's start-up files. If the computer is connected to a printer, print each file. Otherwise, record the contents of each file before calling Dell.

Error message, beep code, or diagnostic code:

Description of problem and troubleshooting procedures you performed:

Contacting Dell

For customers in the United States, call 800-WWW-DELL (800-999-3355).



NOTE: If you do not have an active Internet connection, you can find contact information on your purchase invoice, packing slip, bill, or Dell product catalog.

Dell provides several online and telephone-based support and service options. Availability varies by country and product, and some services may not be available in your area. To contact Dell for sales, technical support, or customer service issues:

- 1** Visit support.dell.com, and verify your country or region in the **Choose A Country/Region** drop-down menu at the bottom of the page.
- 2** Click **Contact Us** on the left side of the page, and select the appropriate service or support link based on your need.
- 3** Choose the method of contacting Dell that is convenient for you.

Index

C

- connecting
 - Internet, 28
 - modem, 21
 - monitor, 17
 - network, 23
 - network cable, 21
 - power cables, 22
- contacting Dell, 65, 71

D

- Dell
 - contacting, 65, 71
 - software updates, 51
 - Support Utility, 51
 - technical support and customer service, 66
 - Technical Update Service, 49
- Dell Diagnostics, 50
 - starting from the Drivers and Utilities media, 50
 - starting from your hard drive, 50
- Dell Factory Image Restore, 58
- Dell Technology Guide, 64
- DellConnect, 66
- Desktop System Software, 63

- diagnostics
 - Dell, 50
- documentation, 63
 - Dell Technology Guide, 64
 - Service Manual, 64
- drivers, 53
 - Drivers and Utilities media, 63
 - identifying, 53
 - reinstalling, 54
 - returning to a previous version, 54
- Drivers and Utilities media, 54, 63
 - Dell Diagnostics, 50

E

- End User License Agreement (EULA), 64
- ergonomics information, 64
- Express Service Code, 63

F

- Files and Settings Transfer Wizard, 30
- finding information, 63

I

- Internet
 - connecting, 28
 - setting up, 28

L

- license label, 64

M

- media
 - Drivers and Utilities, 63
 - operating system, 63
- memory
 - troubleshooting, 47

N

- networks, 23
 - connecting, 23

O

- operating system
 - Dell Factory Image Restore, 58
 - media, 60
 - reinstalling, 63
 - System Restore, 56
- Operating System media, 63
- operating system product key, 64

P

- phone numbers, 71
- power
 - power light conditions, 46
 - troubleshooting, 46
- problems
 - restore to previous state, 57

R

- regulatory information, 64
- reinstalling
 - drivers and utilities, 54
 - software, 53

S

- safety information, 64
- Service Manual, 64
- Service Tag, 63
- setup
 - computer, 17
 - installing your computer in an enclosure, 26
 - Internet, 28
 - quick setup, 17
- software
 - problems, 48
 - reinstalling, 53
 - troubleshooting, 48-49
 - updates, 49

- specifications
 - all, 35
 - audio, 36
 - connectors, 39
 - controls and lights, 41
 - drives, 37
 - environmental, 44
 - expansion bus, 36
 - memory, 35
 - physical, 43
 - power, 42
 - processor, 35
 - system information, 35
 - video, 36
- support, 65
 - contacting Dell, 71
 - DellConnect, 66
 - online services, 66
 - regional, 66
 - technical support and customer service, 66
- support information, 64
- System Restore, 56-57

T

- Terms and Conditions, 64
- transferring information to a new computer, 30
- troubleshooting, 45, 64
 - blue screen, 49
 - computer not responding, 48
 - Dell Diagnostics, 50
 - memory, 47

- power, 46
- power light conditions, 46
- program crashes, 48
- programs and Windows compatibility, 48
- restore to previous state, 56-57
- software, 48-49
- tips, 51

U

- updates
 - software and hardware, 49

V

- view
 - back, 8, 11, 14-15
 - back panel connectors, 9, 12, 14, 16
 - front, 10, 13, 15

W

- warranty information, 64
- Windows License label, 64
- Windows Vista
 - Dell Factory Image Restore, 58
 - Device Driver Rollback, 54
 - Program Compatibility wizard, 48
 - reinstalling, 63
 - returning to a previous device driver version, 54
 - System Restore, 56-57

Windows XP

Device Driver Rollback, 54

Files and Settings Transfer

Wizard, 30

reinstalling, 63

returning to a previous device

driver version, 54

setting up Internet

connection, 29

System Restore, 56-57

wizards

Files and Settings Transfer

Wizard, 30

Program Compatibility wizard, 48